

Desire Series



Type(s)

Project

Date

Notes

GENERAL INFORMATION

The ETC Desire D60 fixture puts the seven-color x7 system into a high-brightness, 60-emitter, round theatrical washlight. Highly efficient primary lenses and careful color choices make the D60 fixture ideal for stage, studio and anywhere strong color and high-intensity are requirements. The x7 Color System produces the widest range of spectrally-balanced saturated and tinted color choices available. The D60's rugged die-cast enclosure; quiet, fan-cooled operation; multiple lens options; and advanced user interface make it ideal for multiple applications.

D60 LED ARRAY OPTIONS

D60 fixtures are based on the x7 Color System that uses seven different LED colors to achieve true, usable broad-spectrum color. The D60 luminaire is available with any one of the following x7 color arrays (not interchangeable) to best suit the intended application:

- D60 Vivid – the x7 Color System array balanced for best all-around use as a color-changing wash fixture
- D60 Lustr+ – optimized array with six colors plus high-intensity white LEDs to create an ideal frontlight wash fixture for full-range color, with an emphasis on lighter colors and white and natural illumination of skin tones

ORDERING INFORMATION

Selador D60

MODEL	DESCRIPTION	ETL PART NUMBER	CE PART NUMBER	
SELD60VI	D60 Vivid	7410A1601	7410A1601-0X	
SELD60LI	D60 Lustr+	7410A1605	7410A1605-0X	

Note: D60 luminaires ship with a hanging yoke, a Very Narrow secondary lens and an input lead with connector of choice. See page 7 for connector options. C-clamps are not included.
 Color options: -1 / -1X = white, -5 / -5X = silver gray/custom colors



PRODUCT SPECIFICATIONS

Source

LED details	60 Lumileds LUXEON® Rebel LED
Max lumens	Vivid: 3,760 Lustr+: 4,317
Lumens per watt	Vivid: 28.8 Lustr+: 33.33
L70 rating (hours to 70% output)	50,000 hours

Color

Colors used	Lustr+: Red, Amber, Green, Cyan, Blue, Indigo, White Vivid: Red, Red-Orange, Amber, Green, Cyan, Blue, Indigo
Color temperature range	2700–6500 K
Calibrated array	Yes
Red shift	Yes

Optical

Beam angle range	8°–71°
Aperture size	9 in
Pattern projection	No
Pattern size	N/A
Camera flicker control/Hz range	Yes: 900–25,000 Hz
Notes	Secondary lenses available for multiple beam-spread options

Control

Input method	DMX512 via 5-pin XLR
Protocols	DMX512/RDM
Modes (footprint)	See page 6
RDM configuration	Yes
UI type	LCD
Local control	Yes
Onboard presets	Yes
Onboard sequences	Yes
Onboard effects	No
Fixture-to-fixture control	Yes
Notes	15-bit virtual dimming engine

Electrical

Voltage range	100–240 VAC 50/60 Hz
Input method	Neutrik powerCON® in and thru Requires power from non-dimmable source
Inrush	15 A at 120 V (First half-cycle) 40 A at 240 V (First half-cycle)
Fixtures per circuit	9 (15 A via power thru) 10 (R20 via module or similar)
Wattage typical	161 W
Current draw	1.21 A at 120 V 0.57 A at 240 V

Thermal

Ambient operating temp	-20°–40°C (-4°–104°F)
Fan (controllable)	Yes (yes)
Droop compensation	Yes
dB range	25 dBA average at 1 m (more details on page 8)
BTUs/hour	549

Physical

Materials	Die-cast, all metal housing
Color options	Black, white, silver, or custom color
Mounting options	Yoke
IP rating	IP20
Weight	8.7 kg (19.1 lb)
Included accessories	Very Narrow Round diffuser, power cable (see page 7), optional yoke/floor stand

Warranty

Fixture	5 years
LED array	10 years

Regulatory and Compliance

Approved regulatory standards	UL 1573 CSA C22.2 No. 166 CE Compliant EAC Compliant
-------------------------------	---

ETC utilizes a nationally recognized third-party lab for luminaire testing according to IES LM-84. See etconnect.com/About/News/ETC-Fixture-Ratings-and-Warranties-Extended.aspx.

All LED sources experience some lessening of light output and some color shift over time. LED output will vary with thermal conditions. In individual situations, LEDs will be used for different durations and levels. This can eventually lead to minor alterations in color performance, necessitating slight adjustments to presets, cues or programs.

PRODUCT FEATURES



INDUSTRY LEADING WARRANTY
Five-year warranty on the full fixture and a ten-year warranty on the LED array.

MULTIPLE LED ARRAY OPTIONS
Also available in static white arrays

USER FRIENDLY INTERFACE
With multiple modes and fixture settings.

COLOR METRIC INFORMATION

DESIRE D60 LUSTR+ 3200 K TM-30-18

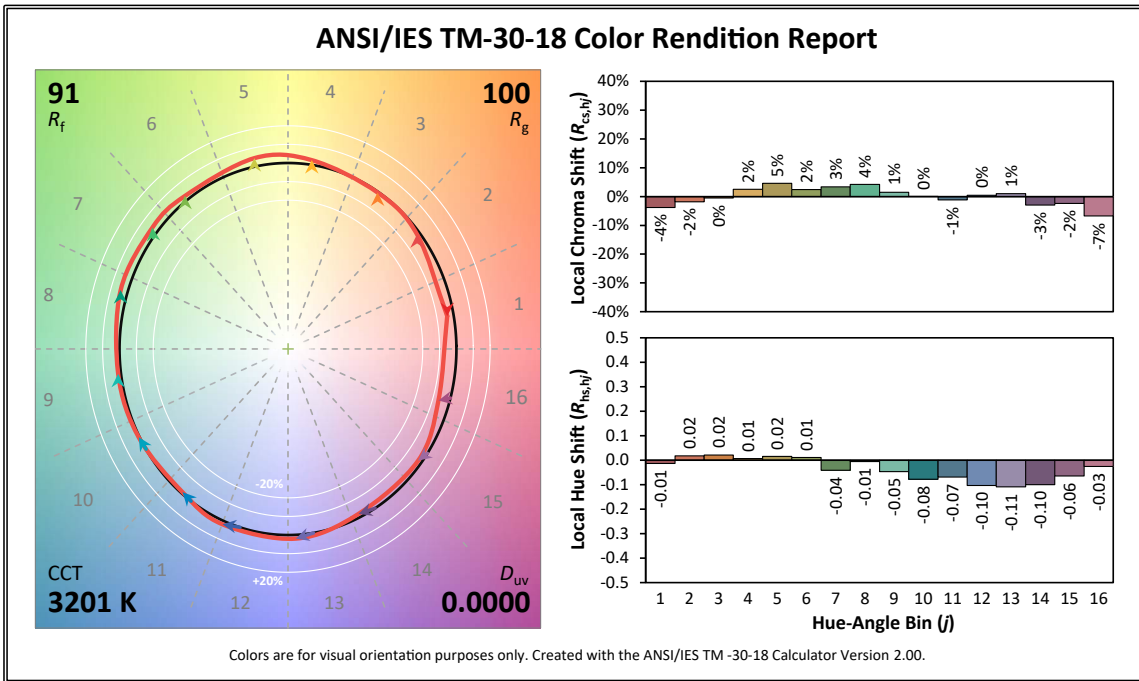

COLOR METRIC INFORMATION

DESIRE D60 LUSTR+ 5600 K TM-30-18

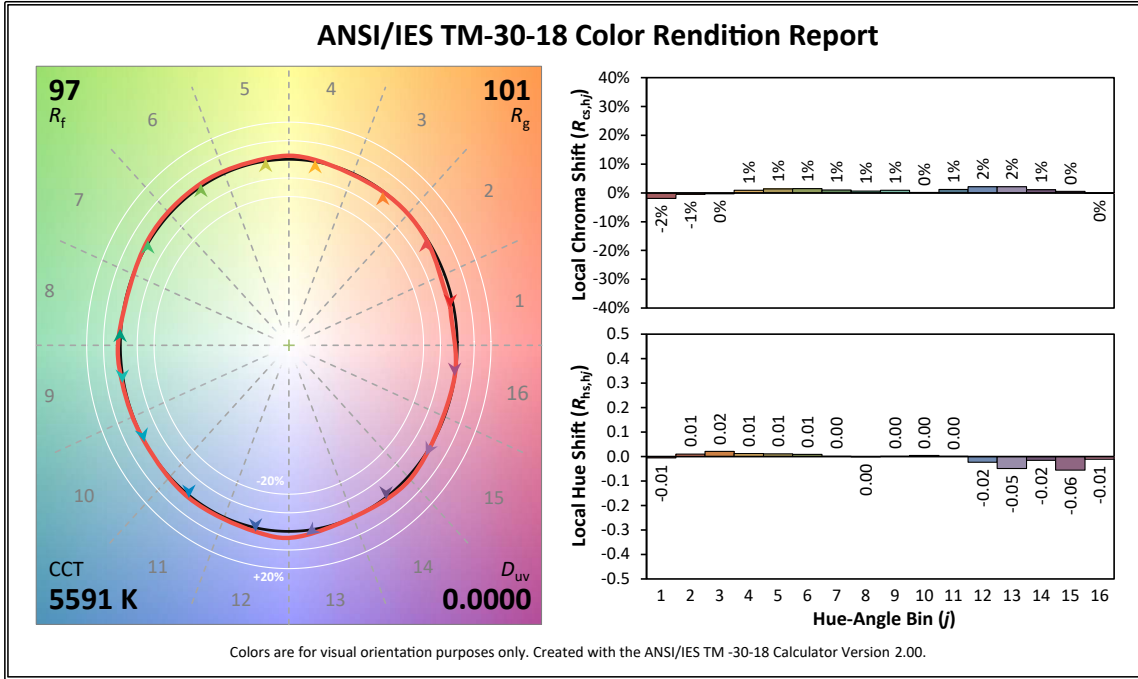

DESIRE D60 VIVID 3200 K TM-30-18

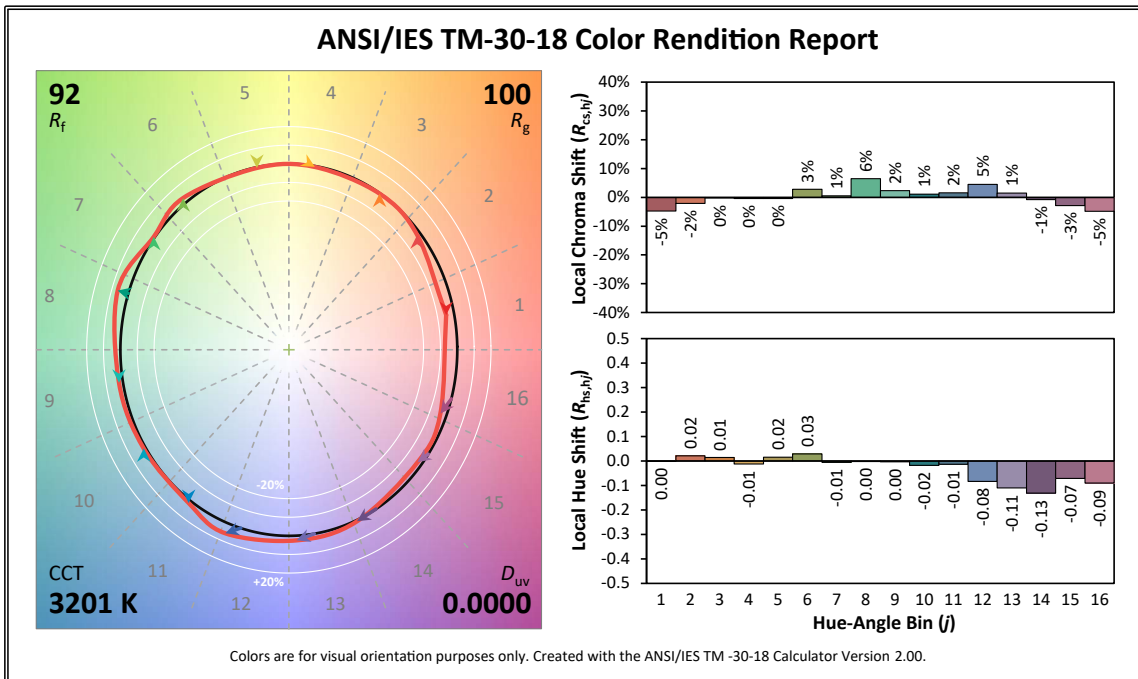

COLOR METRIC INFORMATION

DESIRE D60 VIVID 5600 K TM-30-18

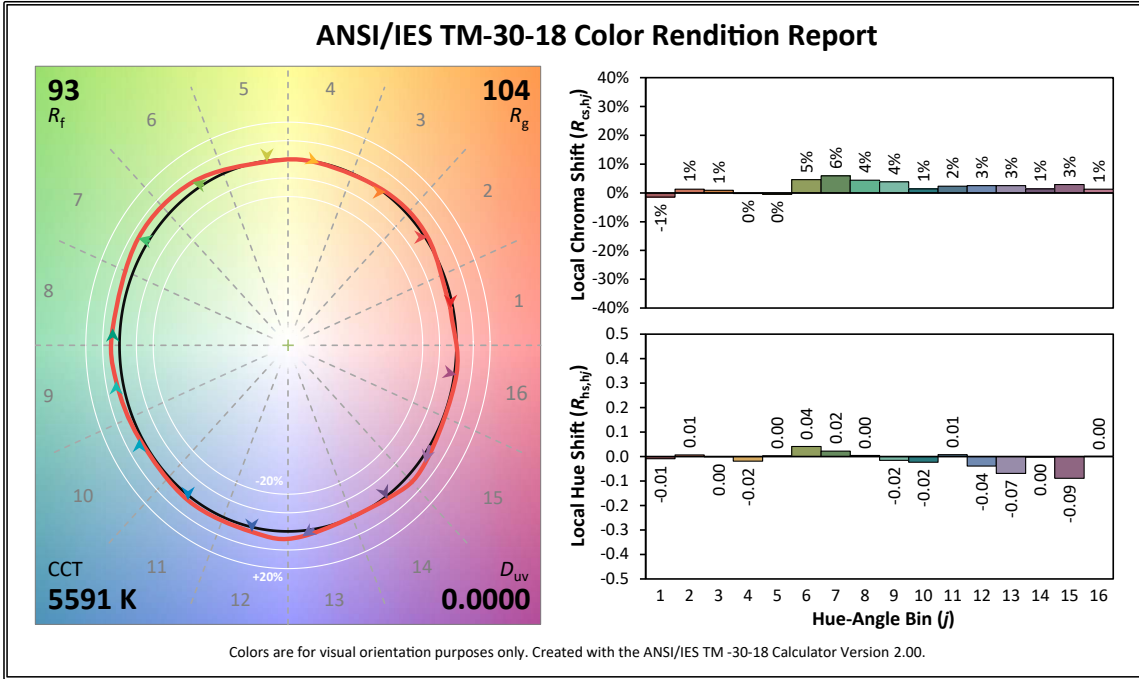

CRI AND CQS RATINGS

Desire fixtures were evaluated for CRI and CQS performance using measured output spectrum and optimized mix solutions for a best spectral match to black body sources at 3200 K and 5600 K.

FIXTURE	CRI	CQS	COLOR FIDELITY	DUV
D60 Vivid at 3200 K	87	89	89	0.000
D60 Vivid at 5600 K	90	92	92	0.000
D60 Lustr+ at 3200 K	86	88	88	0.000
D60 Lustr+ at 5600 K	93	92	92	0.000
D60 Studio HD at 3200 K	89	90	91	0.000
D60 Studio HD at 5600 K	92	94	94	0.000
D60 Studio Daylight at 5600 K	71	70	63	0.001
D60 Studio Tungsten at 3000 K	86	86	86	0.001

All D60 luminaire versions provide excellent color rendering to the eye, particularly at higher color temperature settings, such as 5600 K. In most cases the Duv is 0.000. A Duv rating of 0.000 indicates that the color mix used is exactly on the black body line, with no green or magenta tint.

ADDITIONAL ORDERING INFORMATION

SECONDARY LENS OPTIONS

The following lenses are cut for D60 fixtures and create round, linear or oblong field patterns as described below. These lenses are not sized for use in Selador Classic fixtures.

Note: This is the same material as Selador Classic lenses.

MODEL	DESCRIPTION	PART NUMBER	
Narrow Linear Field	Linear lenses may be combined to create desired field size		
SELLN-9	9 in narrow lens	7410K1033	
SELLM-9	9 in medium lens	7410K1034	
SELLW-9	9 in wide lens	7410K1035	
SELLEW-9	9 in extra wide lens	7410K1036	
Round Field	Any one of the following round lenses may be installed permanently in the fixture at the factory as a special order		
SELRN-9	9 in narrow lens (round field)	7410K1026	
SELRM-9	9 in medium lens (round field)	7410K1027	
SELRW-9	9 in wide lens (round field)	7410K1028	
SELRXW-9	9 in extra wide lens (round field)	7410K1040	
Oblong Field			
SELON-9	9 in narrow lens (oblong field)	7410K1029	
SELOM-9	9 in medium lens (oblong field)	7410K1030	
SELOW-9	9 in wide lens (oblong field)	7410K1031	

[Desire lenses compared to Source Four PAR EA](#)

LENS INFORMATION

Desire diffusion angle measurements

NOMINAL									
	No Lens	Very Narrow	Narrow	Medium	Wide	Extra Wide	Narrow Oval	Medium Oval	Wide Oval
		25°	35°	45°	75°	N/A	20° x 40°	30° x 70°	35° x 80°
D60									
LUSTR+	18	22	27	42	69	104	20 x 37	25 x 60	30 x 82
VIVID	18	22	27	42	69	104	20 x 37	25 x 60	30 x 82
STUDIO HD	18	23	28	42	69	104	21 x 29	25 x 61	30 x 82
STUDIO D	22	25	30	43	70	105	24 x 39	28 x 62	32 x 80
STUDIO T	23	25	30	43	70	105	24 x 39	28 x 62	32 x 80

Values in black refer to old lens descriptions.

ADDITIONAL ORDERING INFORMATION
Power Input Cables

Use information below to order 5 ft power input leads with factory-fitted connectors. CE Fixtures ship with powerCON to bare end cable in the box.

MODEL	DESCRIPTION	
DPA-A	5 ft powerCON to parallel blade U-ground (Edison) connector	
DPA-B	5 ft powerCON to 20 A two-pin and ground (stage pin) connector	
DPA-C	5 ft powerCON to grounded 20 A twistlock connector	
DPA-X	5 ft powerCON to bare-end power input lead	

Power Thru Jumpers

Note: Power thru jumpers connect to fixture's output (thru) connector to provide link to successive fixtures.

MODEL	DESCRIPTION	PART NUMBER	
DPJ-5	5 ft powerCON to PowerCON fixture to fixture jumper	7410B7020	
DPJ-10	10 ft powerCON to powerCON fixture to fixture jumper	7410B7010	

Fixtures Accessories

MODEL	DESCRIPTION	PART NUMBER	
SELD60FSY	Yoke with floor-stand attachment	7410K1022	
490BD	Barn door (Use only as a flexible top hat to diminish aperture glare. Not for beam shaping.)	PSF1099	
490CF	Color frame (use for round and oblong lenses)	7410A3040	
490L	Egg crate louver	PSF1100	
490PTH3	Top hat 3 in tube	PSF1097	
490PTH6	Top hat 6 in tube	PSF1096	
490PHH	Half hat 6 in tube	PSF1098	
400CC	C-Clamp (does not ship with fixture)	7060A2009 (not CE)	
400SC	Safety cable (30 in)	7060A1022	
DPSJ-25	25 ft PowerCON-to-Edison input power cable with inline switch	7400B7030	

CONTROL OPTIONS

User settings on D60 fixtures allow multiple operational modes and settings for either console operation via DMX protocol or stand-alone operation. The expanded LCD display provides easy navigation to all possible settings and options. Some of the setting options are:

- Multiple DMX choices ranging from a simple RGB profile – which effectively controls all seven LED colors via three channels – to nine-channel ‘direct’ color and intensity control
- Multiple dimming curve options
- Preset colors and effects for stand-alone (no console required) operation
- White point selection – white light and color behavior based on a specific color temperature white light, i.e., 3200 K, 5600 K, etc.
- Loss of data behavior options – instant off, hold last look for two minutes, etc.
- Output modes – three output options that offer the user a choice between maximum output and maximum consistency

See the User Manual for a complete explanation of all of the control settings and options for the D60.

Quick Setups

Use one of five Quick Setups on the fixture display to get started. You can modify the setting as needed.

Setting Title	Profile	Description	Typical Features*
General	Direct	Factory default: For general-purpose use, including interior architectural applications	<ul style="list-style-type: none"> • Standard dimming curve • Regulated output for color consistency
Stage	HSI Plus 7 Enabled	Theatrical lighting: Duplicates the color and dimming behavior of tungsten stage lighting fixtures	<ul style="list-style-type: none"> • Incandescent dimming curve • Regulated output for color consistency • 3200 K white point setting
XT Arch	HSI	Exterior architectural lighting: Provides a high degree of color consistency in high ambient temperature environments	<ul style="list-style-type: none"> • Standard dimming curve • Protected output • 3200 K white point setting
High Impact	RGB	Event lighting: Enables quickest response, simple RGB control and strobe channel for maximum effect usage	<ul style="list-style-type: none"> • Quick dimming curve • Boost mode for maximum intensity • 5600 K white point setting
Studio	Studio	Studio Factory Default: Enables three-parameter control of white light (intensity, white point, and tint) via DMX from a console or console-free fixture display	<ul style="list-style-type: none"> • Linear dimming curve • Regulated output mode for color consistency

*See user manual for complete list of features for each Quick Setup

CONTROL OPTIONS

DMX Input Channel Profiles

DMX Profile	DMX Channels	Channel Assignments	Notes
Direct	10	1 – Red 2 – Orange (white if Lustr+) 3 – Amber 4 – Green 5 – Cyan 6 – Blue 7 – Indigo 8 – Intensity 9 – Strobe 10 – Fan Control	Direct control of each individual color with a separate master intensity channel. Color calibration of LEDs is not active in this mode. The ten-channel profile will produce the highest-quality color crossfades.
HSI	6	1 – Hue (coarse) 2 – Hue (fine) 3 – Saturation 4 – Intensity 5 – Strobe 6 – Fan Control	High-resolution hue (two channels), saturation, and intensity control. HSI mode will produce color crossfades around the color space.
HSIC	7	1 – Hue (coarse) 2 – Hue (fine) 3 – Saturation 4 – Intensity 5 – Strobe 6 – Fan Control 7 – Color Point (CCT)	High-resolution hue, saturation and intensity control as above, with the addition of a color-point channel to adjust the color temperature of the fixture in both white light and color. Color crossfade performance is the same as HSI.
RGB	6 (Ch. 4 not used)	1 – Red 2 – Green 3 – Blue 4 – n/a 5 – Strobe 6 – Fan Control	Effectively addresses all seven colors via three channels of control. RGB profile will produce medium-quality color crossfades
Studio	6 (Ch. 4 not used)	1 – Intensity 2 – Color Point (CCT) 3 – Tint 4 – n/a 5 – Strobe 6 – Fan Control	Controls fixture as a white light unit. If no DMX, (console input, for example) is present, fixture can be adjusted for these three parameters on the UI at the back of the unit.
Additional profile options			
Plus 7		Seven additional color-control channels are available in RGB, HSI, and HSIC input profile settings. For example, HSI with ‘Plus 7’ enabled becomes a 15-channel profile: 1 – Hue (coarse) 2 – Hue (fine) 3 – Saturation 4 – Intensity 5 – Strobe 6 – Fan Control 7 – n/a 8 – Plus7 Control on/off 9 – Red 10 – Orange (white if Lustr+) 11 – Amber 12 – Green 13 – Cyan 14 – Blue 15 – Indigo	The desired color and intensity are achieved by using the HSI or RGB channels Placing channel seven at a value over 51% gives the fixture a 15-channel profile. Channels 9–15 represent the native colors of the fixture and allow the operator to adjust individual color channels to fine-tune the color output.
Strobe		Variable strobe control: 0% is no strobe. The fixture output will strobe more rapidly as the strobe-channel value approaches 100%.	

PHOTOMETRICS

D60 Vivid

Mode	Degree	Candela	Field Lumens	Beam Lumens	Lumens Per Watt
Boost - cold	17°	170,540	3,760	1,667	28.8
Regulated	17°	132,451	3,050	1,305	28.3

Metric conversions: For meters, multiply feet by 0.3048.
For lux, multiply foot-candles by 10.76.

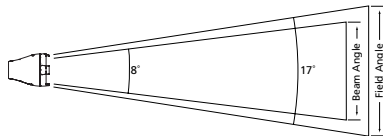

Throw Distance (d)	10 ft 3 m	15 ft 4.6 m	20 ft 6.1 m	25 ft 7.6 m	402.1 ft 122.6 m
Field Diameter	3.0 ft 0.9 m	4.4 ft 1.4 m	5.9 ft 1.8 m	7.4 ft 2.3 m	-
Illuminance (fc)	1,617	719	404	259	1
Illuminance (lux)	17,405	7,736	4,351	2,785	10.76

To determine center beam illumination in foot-candles at any throw distance, divide candela by the throw distance squared.

For field diameter at any distance, multiply distance by 0.295.
For beam diameter at any distance, multiply by 0.145.

Cosine Candela Plot

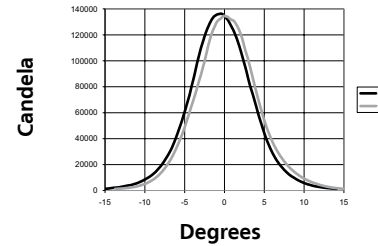

Iso-Illuminance Diagram (Flat Surface Distribution)

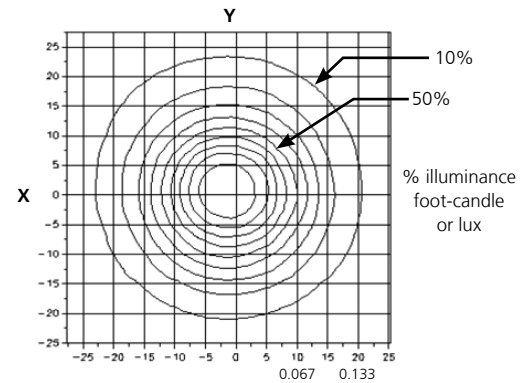

D60 Lustr+

Mode	Degree	Candela	Field Lumens	Beam Lumens	Lumens Per Watt
Boost - cold	16°	195,012	4,317	1,931	33.3
Regulated	16°	180,097	3,850	1,748	32.7

Metric conversions: For meters, multiply feet by 0.3048.
For lux, multiply foot-candles by 10.76.

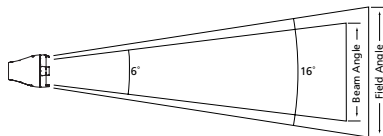

Throw Distance (d)	10 ft 3 m	15 ft 4.6 m	20 ft 6.1 m	25 ft 7.6 m	427.6 ft 130.3 m
Field Diameter	2.9 ft .9 m	4.3 ft 1.3 m	5.8 ft 1.8 m	7.2 ft 2.2 m	-
Illuminance (fc)	1,828	812	457	292	1
Illuminance (lux)	19,676	8,745	4,919	3,148	10.76

To determine center beam illumination in foot-candles at any throw distance, divide candela by the throw distance squared.

For field diameter at any distance, multiply distance by 0.288.
For beam diameter at any distance, multiply by 0.112.

Cosine Candela Plot

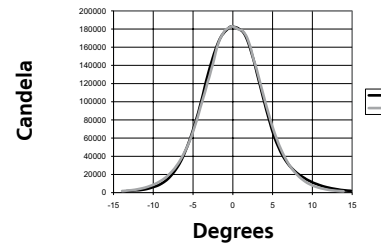

Iso-Illuminance Diagram (Flat Surface Distribution)

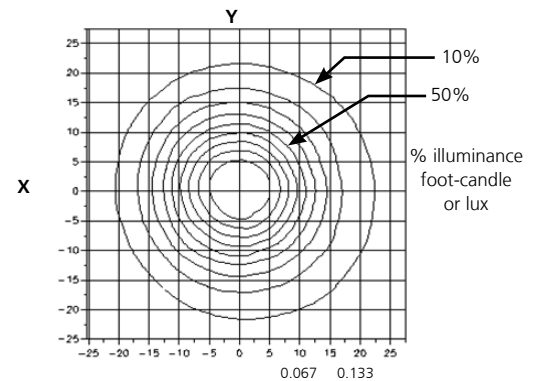

D60 ACOUSTICAL INFORMATION

FIXTURE	SPEED	SOUND PRESSURE LEVEL*
Background noise level in test chamber	N/A	18.3 dBA
Selador Classic	Single fan speed	28.1 dBA
Desire D60	30%	25.0 dBA
	51%	37.4 dBA
	60%	38.6 dBA
	100%	43.1 dBA

*Average of readings from four sides of fixture

The fan in all D60 fixtures is thermostatically controlled to run as needed.

- In regulated mode, fan speed in color-mixing fixtures (Vivid, Lustr+, etc.) will typically not rise above 30% when at full intensity in normal room temperature
- 60% fan speed may be noted in Studio Daylight and Studio Tungsten fixtures at high intensities at room temperature

PHYSICAL

Selador D60 weights and dimensions

WEIGHT*		SHIPPING WEIGHT	
lb	kg	lb	kg
19.1	8.7	21.5	9.7

* Does not include mounting hardware

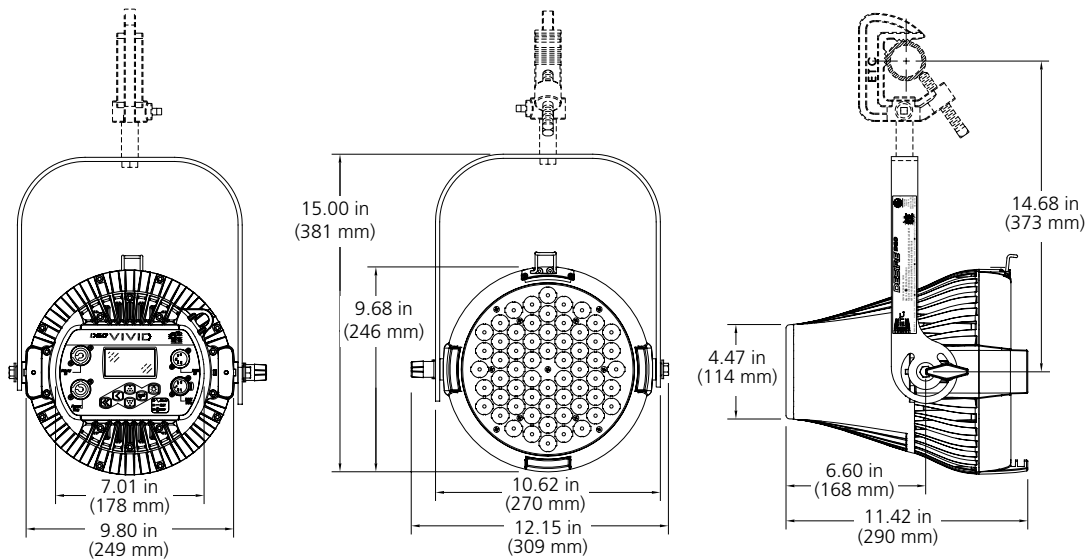

Corporate Headquarters • Middleton, WI USA
 Global Offices • London, UK • Rome, IT • Holzkirchen, DE • Paris, FR • Hong Kong
 Dubai, UAE • Singapore • New York, NY • Orlando, FL • Los Angeles, CA • Austin, TX
 Copyright©2021 ETC. All Rights Reserved. All product information and specifications subject to change. Rev T 2021-08
 *Trademark and patent info: etconnect.com/IF