

ColorSource Series



Type(s)

Project

Date

Notes

GENERAL INFORMATION

ColorSource PAR offers a quality of build and light that has never been seen in an affordable wash fixture. Using ETC’s RGB-L color system, the ColorSource PAR provides a rich, bright light unlike any other LED wash light in its class.

APPLICATIONS

- Theatres and performance spaces
- Houses of worship
- Universities and schools
- Hospitality
- Retail
- Exhibition centers
- Meeting rooms
- Clubs
- Cafeteriums

PRODUCT FEATURES

- Three array options:
 - Original RGB-L (Red/Green/Blue/Lime)
 - Deep Blue RGI-L (Red/Green/Indigo/Lime)
 - Pearl (Warm and Cool White), see separate datasheet
- Homogenized optics
- Simple user interface with seven-segment display
- powerCON® in and thru
- 5-pin XLR
- LED droop compensation
- Optically calibrated
- Tour-ready, aluminum housing

ORDERING INFORMATION

ColorSource PAR

MODEL	DESCRIPTION	ETL PART NUMBER	CE PART NUMBER	
CSPAR	ColorSource PAR, black	7412A1005	7412A1205	
CSPARDB	ColorSource PAR Deep Blue, black	7412A1008	7412A1208	

Note: ColorSource PAR luminaires ship with a hanging yoke and a power cable with connector of choice. See page 6 for connector options. C-clamps are not included. For additional color options, please add the following: -1 for white, -5 for silver gray or -8 for custom color.



PRODUCT SPECIFICATIONS

Source

LED details	40 Lumileds LUXEON® Z LED
Max lumens	PAR: 3,039 PAR DB: 2,429
Lumens per watt	PAR: 28.1 PAR DB: 27.6
L70 rating (hours to 70% output)*	55,000 hours

Color

Colors used	PAR: red, green, blue, lime PAR Deep Blue: red, green, indigo, lime
Color temperature range	Color mixing
Calibrated array	Yes
Red shift	No

Optical

Beam angle range	14.5° (secondary lenses available for multiple beam-spread options)
Gate size	N/A
Aperture size	7.5 in / 190 mm
Pattern projection	No
Pattern size	N/A
Camera flicker control/Hz range	1,200 Hz (default) 25,000 Hz (via RDM)

Control

Input method	DMX512 via 5-pin XLR connector
Protocols	DMX512/RDM
Modes (footprint)	4 modes, see page 7
RDM configuration	Yes
UI type	Seven-segment, three-button interface
Local control	Yes
Onboard presets	Yes (12)
Onboard sequences	Yes (5)
Onboard effects	No
Fixture-to-fixture control	Yes
Notes	15-bit virtual dimming engine

***Note about LED luminaire lifetime:** ETC utilizes a nationally recognized third-party lab for luminaire testing according to IES LM-84. See etcconnect.com/About/News/ETC-Fixture-Ratings-and-Warranties-Extended.aspx.

All LED sources experience some lessening of light output and some color shift over time. LED output will vary with thermal conditions. In individual situations, LEDs will be used for different durations and levels. This can eventually lead to minor alterations in color performance, necessitating slight adjustments to presets, cues or programs.

Electrical

Voltage range	100–240 VAC 50/60 Hz
Input method	powerCON power in and thru
Inrush	35 A at 120 V (First half-cycle) 49 A at 240 V (First half-cycle)
Fixtures per circuit	9 (15 A power thru connector) 10 (R20 module or similar)
Wattage typical/standby	90 W at 120 V 89 W at 240 V
Current draw	0.75 A at 120 V 0.40 A at 240 V

Thermal

Ambient operating temp	0°–40° C (32°–104° F)
Fan (controllable)	Yes (No)
Droop compensation	Yes
dB range	24.8 dBA average at 1 m
BTUs/hour (RGB-L / DB)	307 / 303

Physical

Materials	Die-cast, all metal housing
Color options	Black, white, silver, or custom color
Mounting options	Yoke, floor stand yoke (available as an accessory)
IP rating	IP20
Weight	3.77 kg (8.3 lb)
Included accessories	Hanging yoke, power cable
User interface	Seven-segment, three-button interface

Warranty

Fixture	5 years
LED array	10 years

Regulatory and Compliance

Approved regulatory standards	cETLus Listed Conforms to UL 1573 Listed Conforms to UL 924 Listed Certified to CSA C22.2 No. 166 Listed Certified to CSA C22.2 No. 141 Listed CE Compliant EAC Compliant
-------------------------------	---

PRODUCT FEATURES



HOMOGENIZED OPTICS

The optics consist of a balanced mix of red, green, blue, and lime LEDs to give the best and brightest color mix possible.



RGB-L ARRAY

The custom four-color blend of LEDs incorporates a hint of lime to increase spectral reach and color depth.



SIMPLE USER INTERFACE

The simple seven-segment display and navigation buttons enable quick setup and recall of built-in presets.

COLOR METRIC INFORMATION

ColorSource Array options – Original vs. Deep Blue

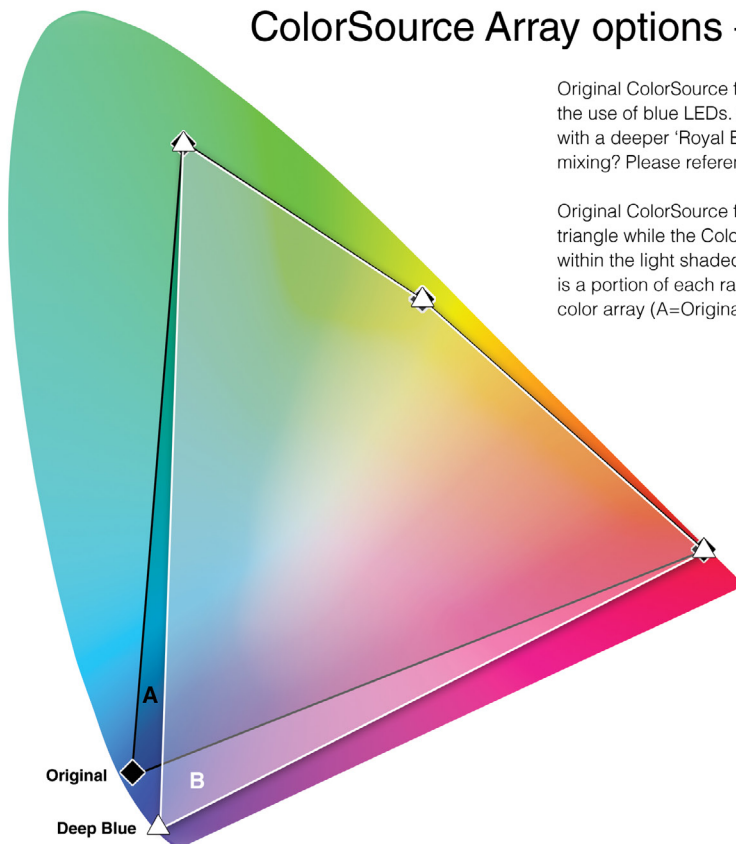

Original ColorSource fixtures use an RGB-L array where the 'B' represents the use of blue LEDs. ColorSource Deep Blue replaces those blue LEDs with a deeper 'Royal Blue' (indigo) LED. How does this impact your color mixing? Please reference the color chart.

Original ColorSource fixtures can reach any color within the dark shaded triangle while the ColorSource Deep Blue fixtures can reach any color within the light shaded triangle. While much of these areas overlap, there is a portion of each range that can only be reached by the respective color array (A=Original, B=Deep Blue).

Common gels found in original ColorSource

Roscolux 095, 075, 076
Lee 363, 119, 721, 722, 132, 141, 183, 172, 325

Common gels found in ColorSource Deep Blue

Roscolux 384, 385, 382, 059, 358, 347, 049, 349,
046, 124, 027, 120
Lee 126, 049, 798, 707, 181, 071, 120, 716

COLOR METRIC INFORMATION

COLORSOURCE PAR 3200 K TM-30-18

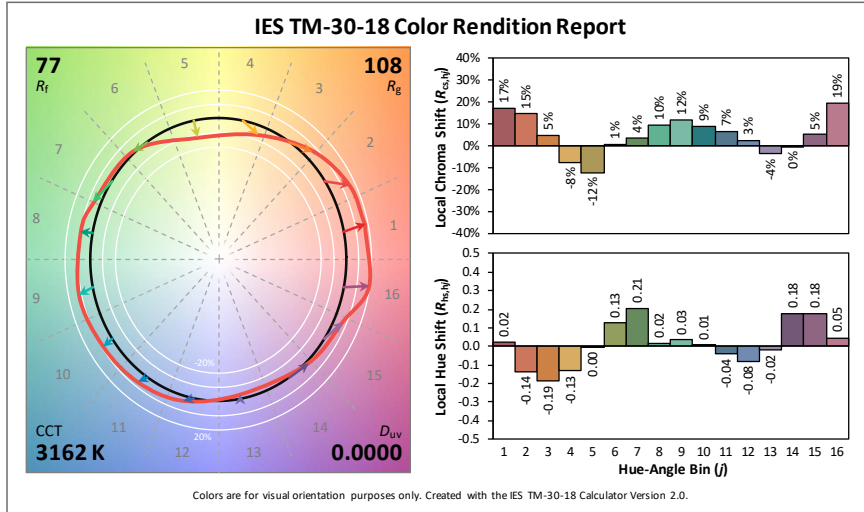

COLORSOURCE PAR 4500 K TM-30-18

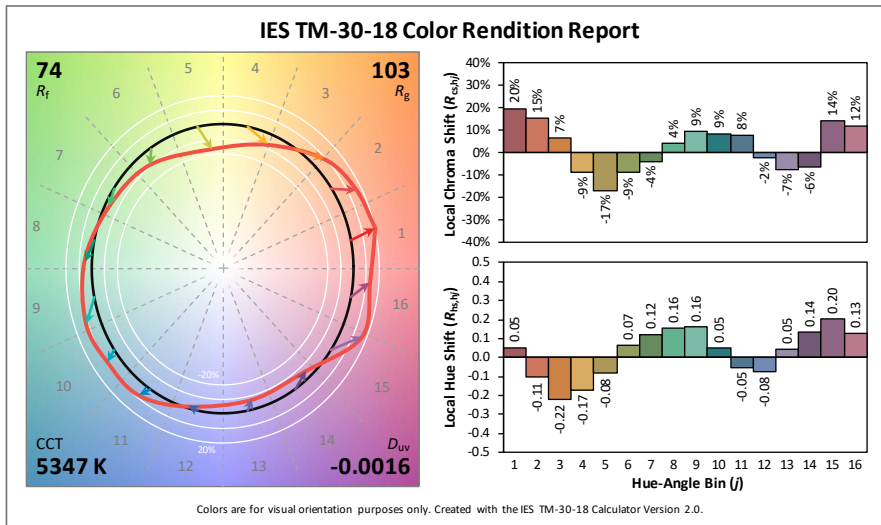

COLORSOURCE PAR 5600 K TM-30-18

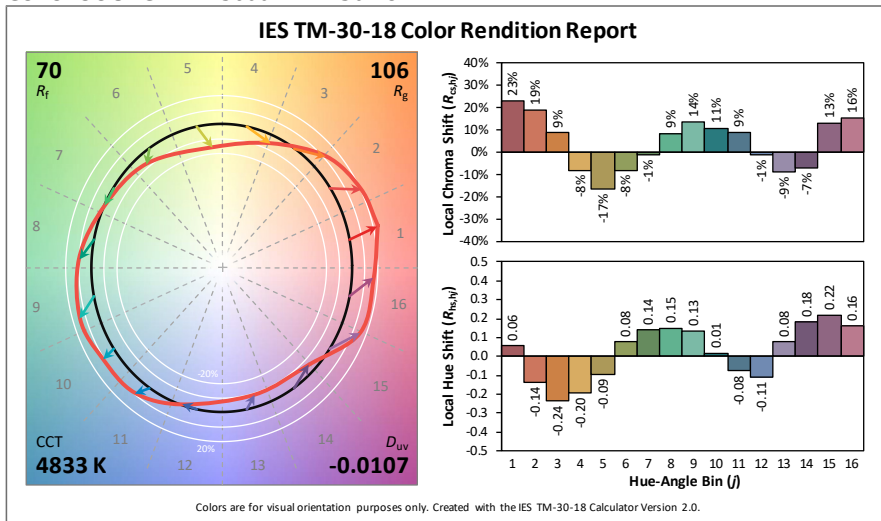

PHOTOMETRICS

ColorSource PAR

Mode	Degree	Candela	Field Lumens	Beam Lumens	Lumens Per Watt
Full ON - Direct	15.3	53,456	3,039	1,905	28.1
3200 K / RGB	15.3	41,323	2,380	1,494	32.9
5600 K / RGB	51,389	2,941	1,831	1,831	28.9

Metric conversions: For meters, multiply feet by 0.3048.
For lux, multiply footcandles by 10.76.

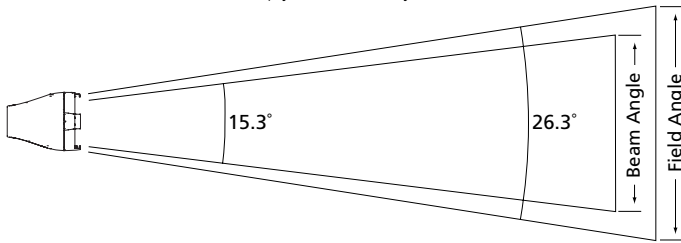

Throw Distance (d)	10 ft 3.0 m	15 ft 4.6 m	20 ft 6.1 m	25 ft 7.6 m	226.1 ft 68.9 m
Field Diameter	4.7 ft 1.4 m	7.0 ft 2.1 m	9.3 ft 2.8 m	11.7 ft 3.6 m	-
Illuminance (fc)	511	227	128	82	1
Illuminance (lux)	5,502	2,445	1,375	880	10.76

To determine center beam illumination in footcandles at any throw distance, divide candela by the throw distance squared.

For field diameter at any distance, multiply distance by 0.467.
For beam diameter at any distance, multiply by 0.269.

ColorSource PAR Deep Blue

Mode	Degree	Candela	Field Lumens	Beam Lumens	Lumens Per Watt
Full ON - Direct	15.3	50,156	2,978	1,874	27.6
3200 K / RGB	15.3	46,653	2,772	1,738	38.3
5600 K / RGB	15.3	46,273	2,723	1,706	26.8

Metric conversions: For meters, multiply feet by 0.3048.
For lux, multiply footcandles by 10.76.

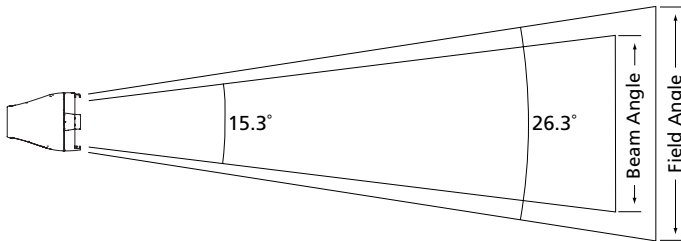

Throw Distance (d)	10 ft 3.0 m	15 ft 4.6 m	20 ft 6.1 m	25 ft 7.6 m	226.0 ft 68.9 m
Field Diameter	4.7 ft 1.4 m	7.0 ft 2.1 m	9.3 ft 2.8 m	11.7 ft 3.6 m	-
Illuminance (fc)	511	227	128	82	1
Illuminance (lux)	5,500	2,444	1,375	880	10.76

To determine center beam illumination in footcandles at any throw distance, divide candela by the throw distance squared.

For field diameter at any distance, multiply distance by 0.467.
For beam diameter at any distance, multiply by 0.269.

LED Wash Lenses

Nominal									
D40	No Lens	Very Narrow	Narrow	Medium	Wide	Extra Wide	Narrow Oval	Medium Oval	Wide Oval
Lustr+	17	21	27	42	68	100	21x37	25x60	30x82
Vivid	18	22	27	42	69	104	20x37	25x60	30x82
Studio HD	18	23	28	42	69	104	21x29	25x61	30x82
Studio D	22	25	30	43	70	105	24x39	28x62	32x80
Studio T	23	25	30	43	70	105	24x39	28x62	32x80
ColorSource PAR	26	28	32	50	77	95	29x44	32x61	32x60

All values are in degrees.

ADDITIONAL ORDERING INFORMATION

Secondary Lens Options

The following lenses are cut for ColorSource luminaires and create round, linear or oblong field patterns as described below. These lenses are not sized for use in Selador Classic fixtures. Linear lenses may be combined to create desired field size.

MODEL	DESCRIPTION	PART NUMBER
Linear Field	Rigid polymer construction; does not require a media frame	
SELLN-7.5	7.5 in / 190 mm narrow lens	7410K1018
SELLM-7.5	7.5 in / 190 mm medium lens	7410K1019
SELLW-7.5	7.5 in / 190 mm wide lens	7410K1020
SELLEW-7.5	7.5 in / 190 mm extra wide lens	7410K1021
Round Field		
SELRVN-7.5	7.5 in / 190 mm very narrow lens	7410K1010
SELRN-7.5	7.5 in / 190 mm narrow lens	7410K1011
SELRM-7.5	7.5 in / 190 mm medium lens	7410K1012
SELRW-7.5	7.5 in / 190 mm wide lens	7410K1013
SELRXW-7.5	7.5 in / 190 mm extra wide lens	7410K1039
Oblong Field		
SELON-7.5	7.5 in / 190 mm narrow lens	7410K1014
SELOM-7.5	7.5 in / 190 mm medium lens	7410K1015
SELOW-7.5	7.5 in / 190 mm wide lens	7410K1016

[Lenses compared to Source Four PAR EA](#)

Typical Lens Field Profiles

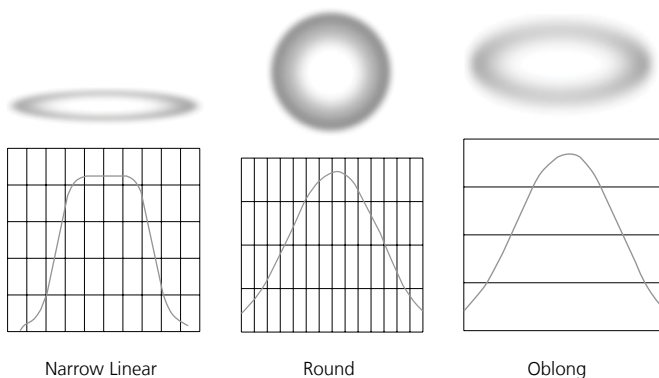

ADDITIONAL ORDERING INFORMATION

Power Input Cables

Use information below to order 5 ft power input leads with factory-fitted connectors. CE Fixtures ship with powerCON to bare end cables in the box.

MODEL	DESCRIPTION	PART NUMBER (NOT CE)	
DPA-A	5 ft / 1.5 m powerCON to parallel blade U-ground (Edison) connector	7410B7037-A	
DPA-B	5 ft / 1.5 m powerCON to 20 A two-pin and ground (stage-pin) connector	7410B7037-B	
DPA-C	5 ft / 1.5 m powerCON to grounded 20 A twistlock connector	7410B7037-C	
DPA-X	5 ft / 1.5 m powerCON to bare-end power input lead	7410B7037-X	

Power-Thru Jumpers

Note: Power-thru jumpers connect to luminaire's output (thru) connector to provide link to successive luminaires.

MODEL	DESCRIPTION	PART NUMBER	
DPJ-5	5 ft powerCON to powerCON fixture-to-fixture jumper	7410B7020	
DPJ-10	10 ft / 3.0 m powerCON to powerCON fixture-to-fixture jumper	7410B7010	

Luminaire Accessories

MODEL	DESCRIPTION	PART NUMBER	
CSPARFSY	Yoke with floor-stand attachment	7412K1000	
400BD	Barn door (use only as a flexible top hat for diminishing aperture glare, not for beam shaping)	PSF1019	
407CF	Color frame (use for round and oblong lenses)	7061A3007	
400L	Egg crate louver	PSF1028	
400PTH3	Top hat 3 in / 76 mm tube	PSF1022	
400PTH6	Top hat 6 in / 152 mm tube	PSF1023	
400PHH	Half hat 6 in tube	PSF1027	
400CC	C-Clamp (does not ship with fixture) (not CE)	7060A2009 (not CE)	
400SC	Safety cable (30 in / 762 mm)	7060A1022	
DPSJ-25	25 ft / 7.6 m powerCON-to-Edison input power cable with inline switch	7400B7030 (not CE)	

CONTROL

DMX Input Channel Profiles

DMX Profile	DMX Channels	Channel Assignments	Notes
5ch (Default)	5	1-Intensity 2-Red 3-Green 4-Blue 5-Strobe	Lime is mixed automatically.
RGB	3	1-Red 2-Green 3-Blue	
1ch	1	1-Intensity	This mode controls the intensity of Preset 1.
Dir	6	1-Intensity 2-Red 3-Green 4-Blue/Indigo* 5-Lime 6-Strobe	Original ColorSource PAR fixture uses blue in channel 4. Deep Blue ColorSource PAR fixture uses indigo in channel 4.

PHYSICAL

ColorSource PAR Dimensions*

HEIGHT		WIDTH		DEPTH	
in	mm	in	mm	in	mm
12.20	310	7.98	203	9.45	240

* Does not include mounting hardware

ColorSource PAR Weights*

WEIGHT*		SHIPPING WEIGHT	
lb	kg	lb	kg
8.3	3.8	10.1	4.6

* Does not include mounting hardware

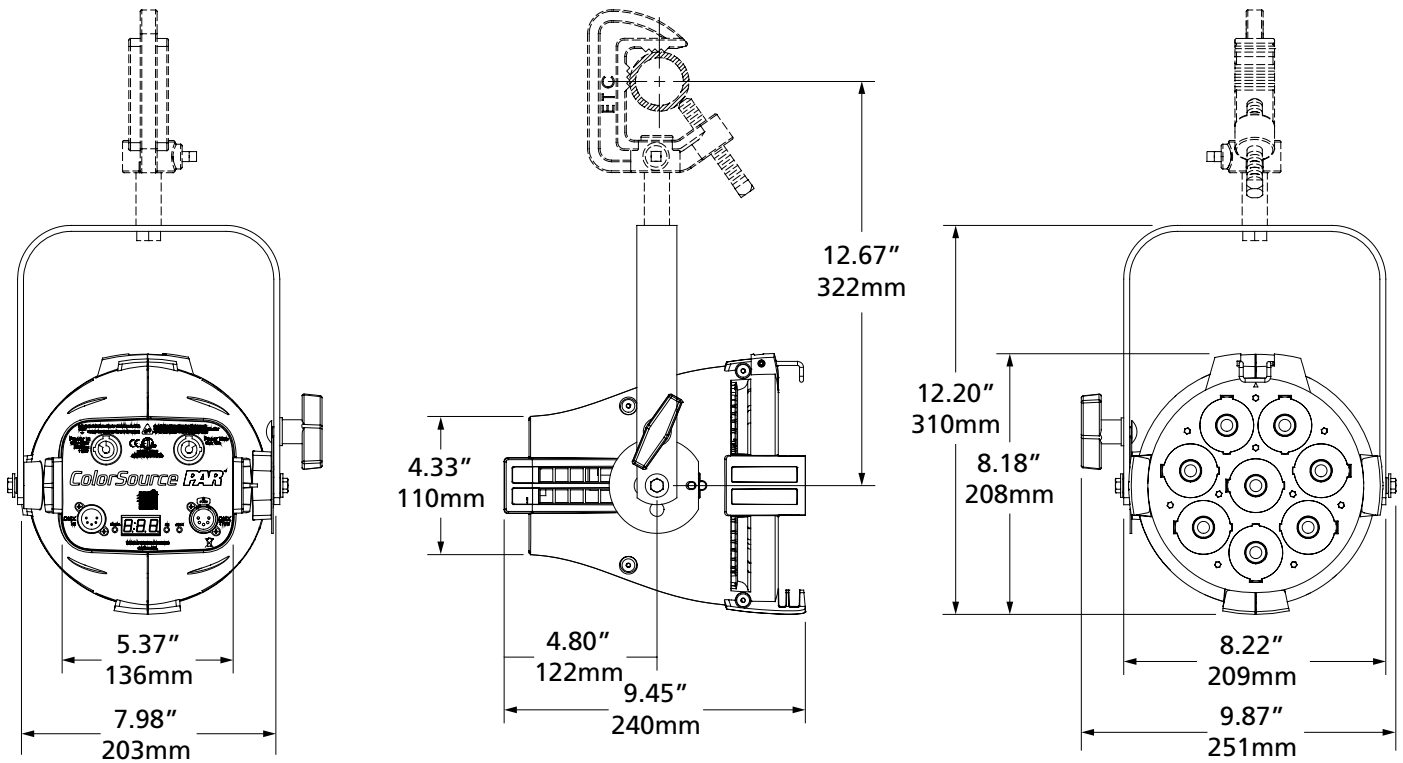

Corporate Headquarters • Middleton, WI USA

Global Offices • London, UK • Rome, IT • Holzkirchen, DE • Paris, FR • Hong Kong
Dubai, UAE • Singapore • New York, NY • Orlando, FL • Los Angeles, CA • Austin, TX

Copyright©2021 ETC. All Rights Reserved. All product information and specifications subject to change. Rev L 2021-05

*Trademark and patent info: etcconnect.com/ETC

etcconnect.com